

fi-6670(A)/fi-6770(A)/fi-6750S Image Scanner

Getting Started

Thank you for purchasing a fi-6670(A) / fi-6770(A) / fi-6750S Color Scanner series. This Getting Started is the startup guide that summarizes the preparatory actions needed before use. Be sure to thoroughly read this manual before you start using the scanner.

Contents

Introduction	2
Regulatory Information	3
Conventions	3
Precautions	4
Safety Information	5
1 Preparation	8
2 Installing the Scanner	13
3 Connecting the Cables	15
4 Installing the Scanner Software	17
5 Test-Scanning Documents	24

Read the Operator's Guide (PDF) included in the Setup DVD-ROM for information about the scanner's operation procedures, daily care, consumables replacement, and troubleshooting.

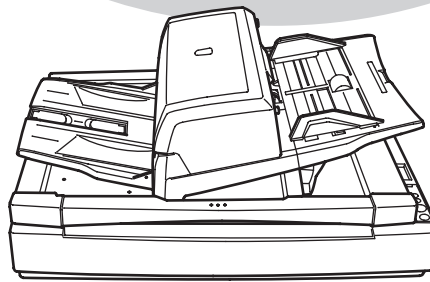
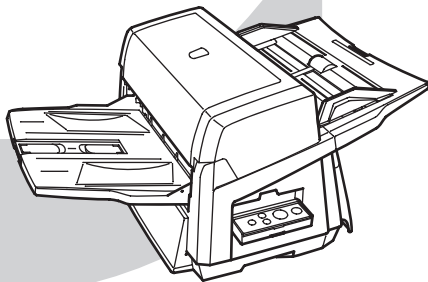

Getting Started

Instructions
préliminaires

Los Geht's

Avvio Rapido

Comenzando

Начало работы

스타트업 가이드

入門指南

Instruções
básicas

Introduction

Thank you for purchasing our fi-6670(A)/fi-6770(A)/fi-6750S series Color Image Scanner.

Scanner Models

This manual covers the following five scanner models, each featuring as:

Model	Description
fi-6670 fi-6670A	Equipped with an automatic document feeder (ADF) for automatic document feeding and duplex scanning. The fi-6670A comes with a color graphics Accelerator (CGA) board as a standard feature. It enables advanced image processing at a high speed when used with Kofax VRS Professional (hereinafter referred to as "Kofax VRS").
fi-6770 fi-6770A	Equipped with an automatic document feeder (ADF) for automatic document feeding and duplex scanning, and a flatbed for scanning documents such as thin paper or thick books. The fi-6770A comes with a color graphics Accelerator (CGA) board as a standard feature. It enables advanced image processing at a high speed when used with Kofax VRS.
fi-6750S	Equipped with an automatic document feeder (ADF) for automatic document feeding and simplex scanning, and a flatbed for scanning documents such as thin paper or thick books. The ADF features simplex scanning only.

Manuals

The following manuals are prepared for the scanner. Read them as needed.

Manual	Description
Package Contents List (paper)	Lists all the items contained in the scanner package. Make sure all are included in the package.
Getting Started (This Manual) (paper, PDF)	Outlines the procedures from installing up to starting the operation of the scanner. Read this manual first. The PDF data is included in the Setup DVD-ROM.
Operator's Guide (PDF)	Provides detailed information on how to operate, and maintain the scanner daily, how to replace the consumables, and how to troubleshoot problems. Included in the Setup DVD-ROM.
ScandAll PRO V2.0 User's Guide (PDF)	Explains how to scan documents by using ScandAll PRO. Included in the Setup DVD-ROM.
ScandAll PRO ScanSnap mode Add-in V1.0 User's Guide (PDF)	Provides information on how to scan documents by using ScandAll PRO ScanSnap mode Add-in. Included in the Setup DVD-ROM.

Manual	Description
TWAIN User's Guide (PDF)	Explains how to install and operate the TWAIN scanner driver. Included in the Setup DVD-ROM.
Image Processing Software Option User's Guide (PDF)	Explains how to install and operate the Image Processing Software Option. Included in the Setup DVD-ROM.
VRS Note (PDF)	Explains how to connect and install Kofax VRS. Included in the Setup DVD-ROM.
Scanner Central Admin 4.0 User's Guide (PDF)	Explains about the overview, installation, operation and maintenance of Scanner Central Admin. Included in the Setup DVD-ROM.
Error Recovery Guide (HTML help)	Details the status of the scanner and explains how to resolve problems encountered. Contains movies that explain how to replace the consumables. Included in the Setup DVD-ROM.
Help - Embedded in scanner drivers	Explains how to use the scanner drivers, and how to configure the settings for them.
Help - Embedded in related applications	Explains how to use and configure the settings for the application software. Use help files as necessary. Can be referenced from the applications.

Trademarks

Microsoft, Windows, Windows Server, Windows Vista, Excel, and SharePoint are either registered trademarks or trademarks of Microsoft Corporation in the United States and/or other countries.

Word is a product of Microsoft Corporation in the United States.

ISIS and QuickScan are trademarks or registered trademarks of EMC Corporation in the United States.

Adobe, the Adobe logo, Acrobat, and Adobe Reader are either registered trademarks or trade names of Adobe Systems Incorporated in the United States and/or other countries.

Kofax and VRS are trademarks or registered trademarks of Kofax, Inc.

ABBYY™ FineReader™ Engine ©2011 ABBYY. OCR by ABBYY

ABBYY and FineReader are trademarks of ABBYY.

Other company names and product names are the registered trademarks or trademarks of the respective companies.

Manufacturer

PFU LIMITED

International Sales Dept., Imaging Business Division, Products Group

Solid Square East Tower, 580 Horikawa-cho, Saiwai-ku, Kawasaki-shi Kanagawa 212-8563, Japan

Phone: (81-44) 540-4538

© PFU LIMITED 2008-2011

Regulatory Information

FCC Declaration

This equipment has been tested and found to comply with the limits for a Class B digital device, pursuant to Part 15 of the FCC Rules. These limits are designed to provide reasonable protection against harmful interference in a residential installation. This equipment generates, uses, and can radiate radio frequency energy and, if not installed and used in accordance with the instruction manual, may cause harmful interference to radio communications.

However, there is no guarantee that interference will not occur in a particular installation. If this equipment does cause harmful interference to radio or television reception, which can be determined by turning the equipment off and on, the user is encouraged to try to correct the interference by one or more of the following measures:

- Reorient or relocate the receiving antenna.
- Increase the separation between the equipment and receiver.
- Connect the equipment into an outlet on a circuit different from that to which the receiver is located.
- Consult your dealer or an experienced radio/TV technician.

FCC warning: Changes or modifications not expressly approved by the party responsible for compliance could void the user's authority to operate the equipment.



The use of a shielded interface cable is required to comply with the Class B limits of Part 15 of FCC rules.

The length of the Power cable must be 3 meters (10 feet) or less.

Canadian DOC Regulations

This digital apparatus does not exceed the Class B limit for radio noise emissions from digital apparatus set out in the Radio Interference Regulations of the Canadian Department of Communications.

This Class B digital apparatus complies with Canadian ICES-003.

Le présent appareil numérique n'émet pas de parasites radioélectriques dépassant les limites applicables aux appareils numériques de la classe B et prescrites dans le Règlement sur le brouillage radioélectrique dictées par le Ministère des Communications du Canada.

Cet appareil numérique de la classe B est conforme à la norme NMB-003 du Canada.

Bescheinigung des Herstellers/ Importeurs

Für den fi-6670(A)/fi-6770(A)/fi-6750S wird folgendes bescheinigt:

- In Übereinstimmung mit den Bestimmungen der EN45014(CE) funkentstört
- Maschinenlärminformationsverordnung 3. GPSGV: Der höchste Schalldruckpegel beträgt 70 dB (A) oder weniger, gemäß EN ISO 7779.

Dieses Gerät wurde nicht für die Benutzung in unmittelbarer Umgebung starker Lichtquellen (z. B. Projektoren) konzipiert.

ENERGY STAR®

PFU LIMITED, a Fujitsu company, has determined that this product meets the ENERGY STAR® guidelines for energy efficiency.

ENERGY STAR® is a registered trademark of the United States.



Use in High-Safety Applications

This product has been designed and manufactured on the assumption that it will be used in office, personal, domestic, regular industrial, and general-purpose applications. It has not been designed and manufactured for use in applications (simply called "high-safety applications" from here on) that directly involve danger to life and health when a high degree of safety is required, for example, in the control of nuclear reactions at nuclear power facilities, automatic flight control of aircraft, air traffic control, operation control in mass-transport systems, medical equipment for sustaining life, and missile firing control in weapons systems, and when provisionally the safety in question is not ensured. The user should use this product with adopting measures for ensuring safety in such high-safety applications. PFU LIMITED assumes no liability whatsoever for damages arising from use of this product by the user in high-safety applications, and for any claims or compensation for damages by the user or a third party.

Conventions

Symbols Used In This Manual

For notational conventions, the following symbols are used in this manual.



This symbol alerts operators to particularly important information. Be sure to read this information.



This symbol alerts operators to helpful advice regarding operation.

Naming Conventions in This Manual

■ Scanners

The scanners are indicated as follows:

Model	Indication	
fi-6670/fi-6670A	ADF type	Scanner
fi-6770/fi-6770A/fi-6750S	Flatbed type	

The explanation in this manual bases on the following models:

- ADF type: fi-6670
- Flatbed type: fi-6770

■ Operating Systems and Software Products

The OSs and products in this manual are indicated as

Product	Indication	
Windows® 2000 Professional (Service Pack 4 or later)	Windows 2000	Windows *1
Windows® XP Home Edition (Service Pack 3 or later) Windows® XP Professional (Service Pack 3 or later) Windows® XP Professional x64 Edition (Service Pack 2 or later)	Windows XP	
Windows Server® 2003, Standard Edition Windows Server® 2003, Standard x64 Edition Windows Server® 2003 R2, Standard Edition (Service Pack 2 or later) Windows Server® 2003 R2, Standard x64 Edition (Service Pack 2 or later)	Windows Server 2003	
Windows Vista® Home Basic (32/64 bit) (Service Pack 1 or later) Windows Vista® Home Premium (32/64 bit) (Service Pack 1 or later) Windows Vista® Business (32/64 bit) (Service Pack 1 or later) Windows Vista® Enterprise (32/64 bit) (Service Pack 1 or later) Windows Vista® Ultimate (32/64 bit) (Service Pack 1 or later)	Windows Vista	
Windows Server® 2008 Standard (32/64 bit) Windows Server® 2008 R2 Standard (64 bit)	Windows Server 2008	
Windows® 7 Home Premium (32/64-bit) Windows® 7 Professional (32/64-bit) Windows® 7 Enterprise (32/64-bit) Windows® 7 Ultimate (32/64-bit)	Windows 7	
Adobe® Acrobat®	Adobe Acrobat*2	

follows:

- *1) Where there is no distinction between the different versions of the above operating system, the general term "Windows" is used.
- *2) All the descriptions in this manual assume the usage of Adobe Acrobat bundled with this product. However, Adobe Acrobat may be upgraded without notice. If the descriptions differ from the screens actually displayed, refer to the Adobe Acrobat Help.

Arrow Symbols in This Manual

Right-arrow symbols (⇒) are used to separate icons or menu options you should select in succession.

Example: Select [Tool] ⇒ [Scan Setting].

Screen Examples in This Manual

The screen examples in this manual are subject to change without notice in the interest of product improvement. If the actual displayed screen differs from the screen examples in this manual, operate by following the actual displayed screen while referring to the user's manual of the scanner application you are using. The screen examples used in this manual are of TWAIN scanner driver, ISIS scanner driver, ScandAll PRO and Quick-Scan Pro™ (which are image capturing software), and Adobe Acrobat.

Precautions

Liability Note

READ ALL OF THIS MANUAL CAREFULLY BEFORE USING THIS PRODUCT. IF THIS PRODUCT IS NOT USED CORRECTLY, UNEXPECTED INJURY MAY BE CAUSED TO USERS OR BYSTANDERS.

Also, keep this manual in a safe place so that it can be easily referred to during use of this product.

While all efforts have been made to ensure the accuracy of all information in this manual, PFU assumes no liability to any party for any damage caused by errors or omissions or by statements of any kind in this manual, its updates or supplements, whether such errors are omissions or statements resulting from negligence, accidents, or any other cause. PFU further assumes no liability arising from the application or use of any product or system described herein; nor any liability for incidental or consequential damages arising from the use of this manual. PFU disclaims all warranties regarding the information contained herein, whether expressed, implied, or statutory.

Use of Mercury



Lamp(s) inside this product contain mercury and must be recycled or disposed of according to local, state, or federal laws.

To avoid unexpected injuries:

- Do not put the substance contained in the lamp in your mouth as it has mercury.
- Do not breathe the chemical liquid contained in the scanner lamps.
- Do not incinerate, crush, or shred the lamps or scanner parts.

Maintenance

The user must not perform repairs on this scanner. Contact the store where you purchased the scanner or an authorized FUJITSU Image Scanner service provider to make repairs to this product.

Warning Label

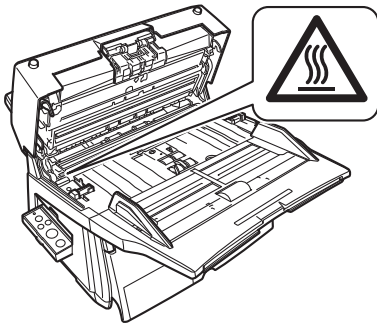

HOT warning label:

The glass surface inside the ADF becomes hot during the operation. Be careful not to touch glass surfaces inside the ADF.

To avoid burns, never touch around the area indicated by this label.



Take care not to pinch your fingers while turning the ADF.



You must **NOT** remove this warning label from your scanner. When it gets old or unreadable by staining or scratches, contact the store where you purchased the scanner or an authorized FUJITSU scanner service provider.

Safety Information

Warning Indications Used In This Manual

The following indications are used in this manual to obviate any change of accident or damage to you and/or the equipment.



This indication alerts operators to an operation that, if not strictly observed, may result in severe injury or death.



This indication alerts operators to an operation that, if not strictly observed, may result in safety hazards to personnel or damage to equipment.



A TRIANGLE symbol indicates that special care and attention is required. The drawing inside the triangle shows the specific caution.



A CIRCLE with a diagonal line inside shows action which users may not perform. The drawing inside or under the circle shows the specific action that is not allowed.



Outline characters on a colored background show instructions users should follow. It may also include the drawing that shows the specific instruction.



The following are important warnings described in this manual.



Do not damage the Power cable.

A damaged Power cable may cause fire or electric shock. Do not place heavy objects on Power cables, or pull, bend, twist, heat, damage or modify Power cables. Do not use damaged Power cables or power plugs, or install any cables or power plugs to loose wall sockets.



Use only specified Power cables and interface cables.

Use only specified Power cables and interface cables. Failure to use the correct cables might cause electric shock and/or equipment failure. Do not use the Power cable provided with the scanner for other devices, since this might cause equipment failure and other troubles or an electric shock.

**Make sure to ground the scanner.**

Make sure to ground to avoid electric shock. Be sure to ground before plugging into a Power outlet.

Unplug from the outlet before removing the ground connection.

**Use the scanner only at the indicated power voltage. Do not connect to multiple-power strips.**

Use the scanner only at the indicated power voltage and current. Improper power voltage or current might cause fire or electric shock. Do not connect to multiple-power strips.

**Do not touch the Power cable with wet hands.**

Do not touch the power plug with wet hands. Doing so might cause electric shock.

**Wipe off any dust from the power plug.**

Wipe off any dust from the metal parts on the power plug or metal fittings with a soft, dry cloth. Accumulated dust might cause fire or electric shock.

**Do not install the scanner in a location that has oil smoke, steam, humidity, and dust.**

Do not install the scanner in a location subject to oil smoke, steam, humidity, and dust. Doing so might cause a fire or electric shock.

**Do not use the scanner if there is a strange odor.**

If you detect excessive heat coming from the scanner or detect smoke, strange smells or noises during the operation, immediately disconnect the power plug from the Power outlet. Before contacting the store where you bought the scanner or an authorized FUJITSU scanner service provider, make sure that any smoke coming from it has completely stopped. Never try fixing such problems by yourself. Doing so is dangerous.

**Disconnect the power if the scanner is damaged.**

If the scanner is damaged for any reason, immediately disconnect the power plug from the Power outlet. Then, contact the store where you bought the scanner or an authorized FUJITSU scanner service provider.

**Do not put liquids inside the scanner.**

Do not insert or drop any metal objects into the ADF slot or ventilation ports on the scanner.

Do not scan any wet documents or documents with paper clips or staples attached.

Do not splash or allow the scanner to get wet.

If foreign objects (water, small metal objects, liquids, etc.) get inside the scanner, immediately disconnect the power plug from the Power outlet. Then, contact the store where you bought the scanner or an authorized FUJITSU scanner service provider. Pay particular attention to this warning in households where there are small children.

**Unplug the scanner when a trouble occurs.**

Immediately unplug the scanner when a trouble occurs.

Never cut the ground connection until the scanner is unplugged from the Power outlet.

**Do not disassemble the scanner.**

Do not take apart or modify the scanner. The inside of the scanner contains high-voltage components.

Touching these components might cause electric shock or fire.

**Do not use aerosol or alcohol sprays near the scanner.**

Do not use any flammable substance or alcohol based cleaning sprays (such as aerosol sprays) to clean the scanner.

Sparks, caused by static electricity, generated when blowing off dust and dirt from the outside of the scanner, may cause a fire.

**Do not place the scanner within the reach of small children.**

To avoid injuries, do not place the scanner in an area where small children may be able to reach.

**Do not touch the heated section for a long time.**

Do not touch the heated section such as the bottom of the scanner for a long time.

Doing so may cause a low-temperature burn on your skin.

**Do not cover the scanner with something during its operation.**







Do not use the scanner while covered with a blanket, etc. Doing so may raise the temperature inside and cause a fire.







**Do not use the scanner where it gets wet.**

Do not use the scanner at a place such as a bathroom, shower room, or swimming pool where it may easily get wet. Doing so might cause electric shock or fire.



The following are important cautions described in this manual

	Do not install the scanner on an unstable work table. When installing the scanner on a work table, make sure that the table is flat and level. Place the scanner so that none of its parts extend beyond the edge of the table. Also, it must be strong enough to support the weights of the scanner and other devices.
	Firmly insert the power plug. Firmly insert the power plug into the Power outlet as far it can go.
	Do not block the ventilation ports. Do not block the ventilation ports. Blocking the ventilation ports generates heat inside of the scanner, which may result in fire or scanner failure.
	Do not place heavy objects or stand on the top of the scanner. Do not place heavy objects on the scanner or stand on its top to perform other work. Doing so might cause injuries and equipment failure.
	Do not use the scanner immediately after moving it from a cold place into a warm room. Do not use the scanner immediately after moving it from a cold place into a warm room. Condensation may occur, which might lead to scanning errors. Let the scanner dry for one or two hours before you use it.
	Before moving the scanner, disconnect the power plug from the Power outlet. Do not move the scanner with the power and interface cables connected as this can damage the cables, which can later cause fire, electric shock as well as injuries. Before moving the scanner, be sure to disconnect the power plug from the Power outlet, and all other interface cables. Make sure that the floor is free of any obstructions.
	Protect the scanner from static electricity. Install the scanner away from strong magnetic fields and other sources of electronic noise. Also, protect the scanner against any static electricity, which can cause the scanner to malfunction. Choose a static-free place to install the scanner.

	Avoid any contact when scanner is in use. Avoid getting a sleeve, necktie, or hair caught up in any scanner mechanism during scanning since this may cause injuries.
	Disconnect the power plug from the Power outlet when the scanner is not in use for a long period of time. When the scanner is not going to be used for a long period of time, be sure to disconnect the power plug from the Power outlet.
	Do not install the scanner in direct sunlight. Do not install the scanner under direct sunlight or near heating apparatus. Doing so might cause excessive heat to build up inside the scanner, which can cause scanner trouble or even fire. Install the scanner in a well-ventilated location.
	Do not try to move or lift the scanner alone. When transporting the scanner, never carry it alone. The scanner is heavy.
	Before moving the scanner, make sure the transport lock is locked. (Flatbed type) When moving the scanner, be sure to lock the transport lock and the ADF transport lock in order to prevent damage to the scanner.
	Handle documents carefully. When handling documents, be careful not to cut your fingers with them.
	Do not make the scanner wet while carrying it outside. When carrying the scanner outside while it is raining or snowing, pay special attention so the scanner does not get wet.

1







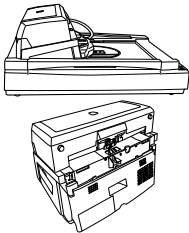

Preparation

Contents of the Scanner Package

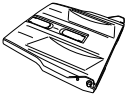
When you unpack the scanner package, make sure that all of the following parts are included in the package.

Make sure the scanner package contains all the parts listed in the package contents list that is included in the package box.

If any parts are missing or defective, contact your FUJITSU scanner dealer or an authorized FUJITSU scanner service provider.

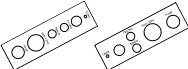
	Scanner (x1)
	ADF paper chute (x1)
	Stacker (x1)
	AC cable (The contents may vary depending on the country and the model purchased.)
	USB cable (x1)
	Setup DVD-ROM (x1)
	Adobe® Acrobat® DVD-ROM (x1)
	Getting Started (x1)
	QuickScan™ Pro brochure (x1)
	Operator panel overlay (x5)

Part Names and Functions

This section describes the scanner parts and their functions.

For information on the function of each part, refer to "Section 1.2 Scanner Parts and Their Functions" in the Operator's Guide.

■ fi-6670/fi-6670A (ADF type)

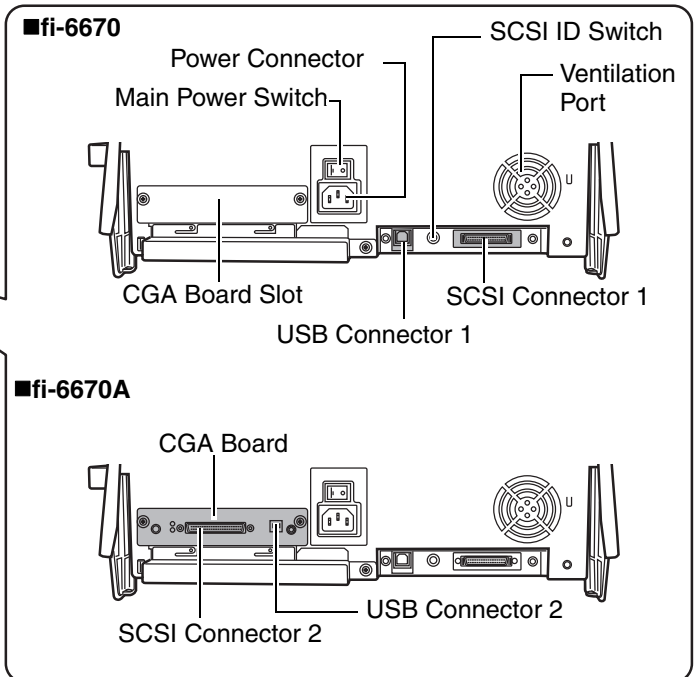
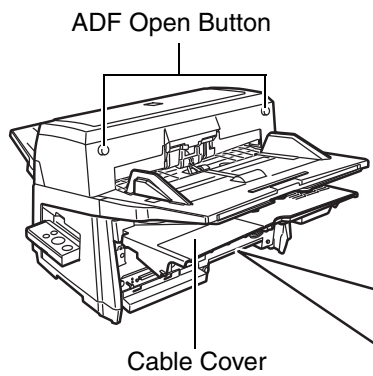
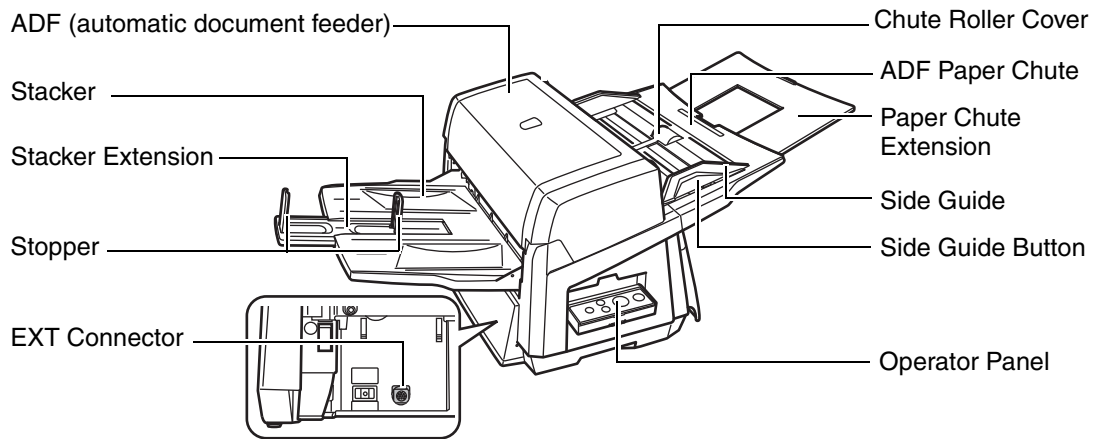

■ fi-6770/fi-6770A/fi-6750S (Flatbed type)

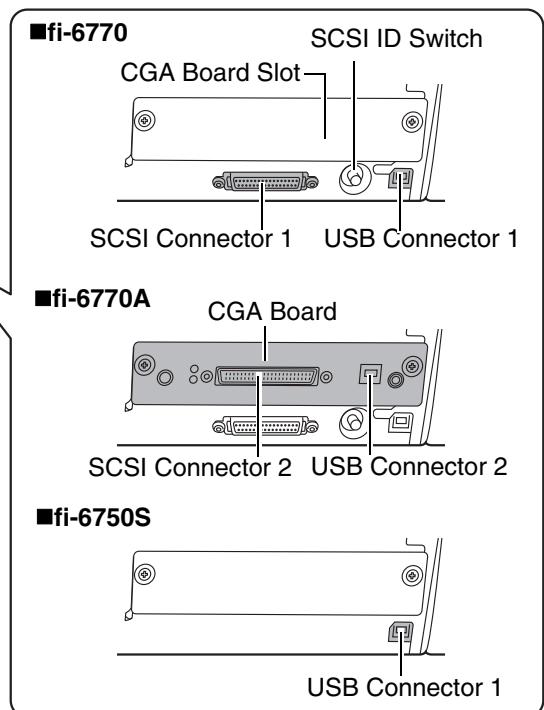
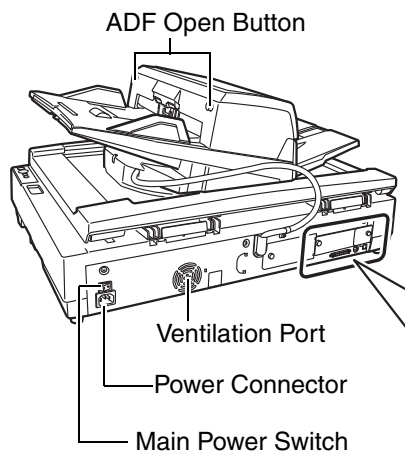
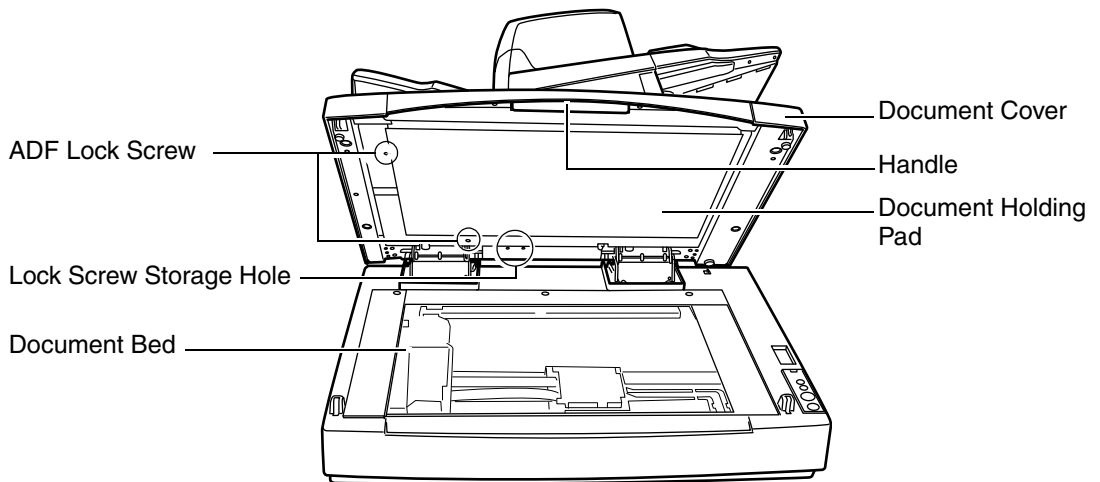
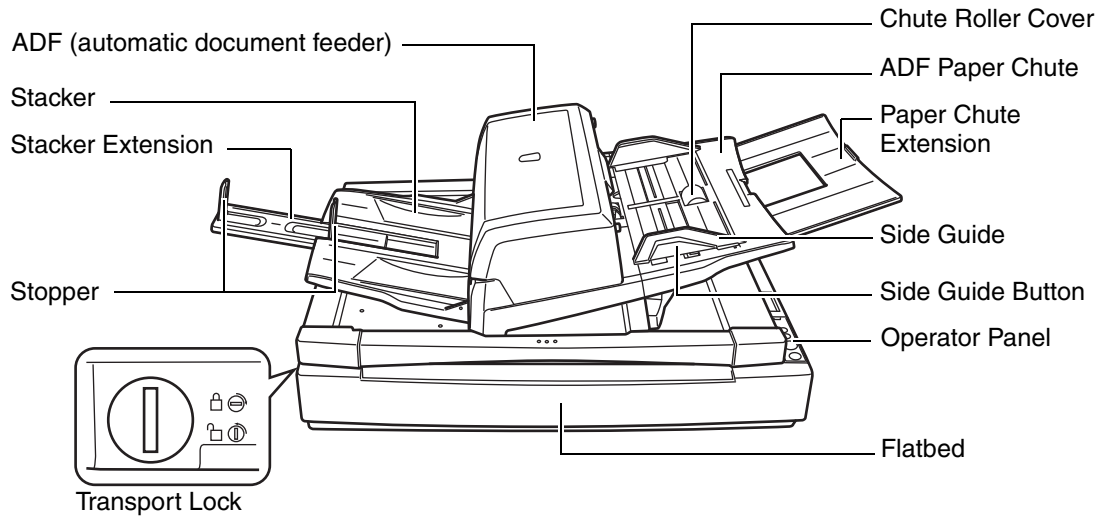

Model-Common Parts

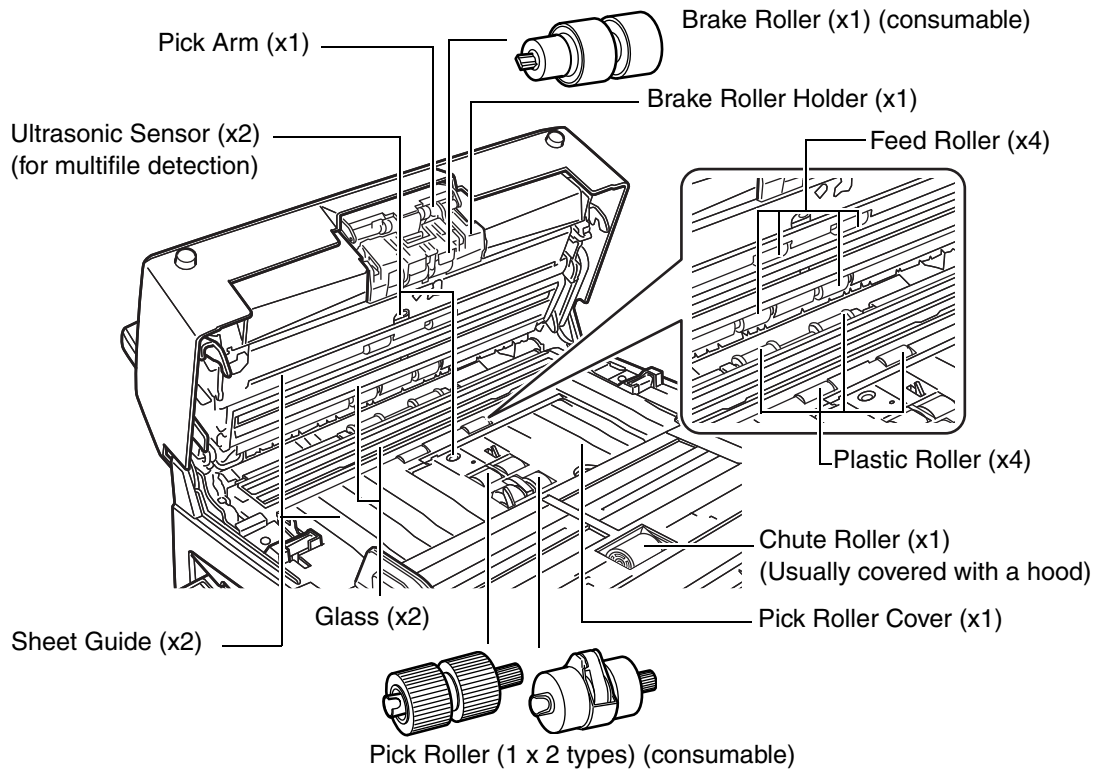

Functions of the Operator Panel

The Operator Panel is comprised of a Function Number Display, buttons, and LEDs, which are used to operate the scanner and to check the scanner status.

For information on how to configure settings for scanning using the [Scan/Stop] or [Send to] button, refer to the help topics the TWAIN scanner driver contained in the Setup DVD-ROM, or the section "Using the Scanner Buttons to Start A Scan Quickly" in the Operator's Guide.

ADF type

Two Operator Panels are mounted on the scanner; one each on each side. You can use whichever is convenient for you. They can be folded back in place when they are not used. The scanner status can be checked while the Operator Panels are folded back in place.

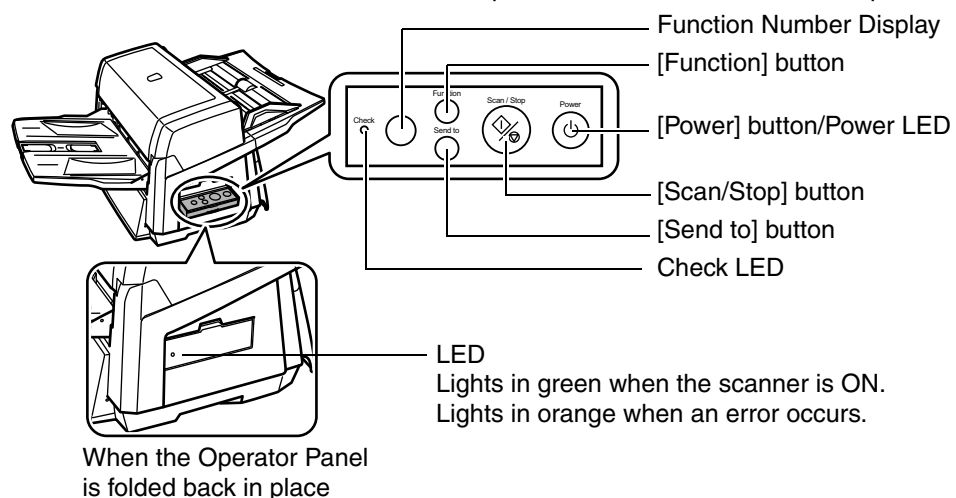

■ Flatbed type

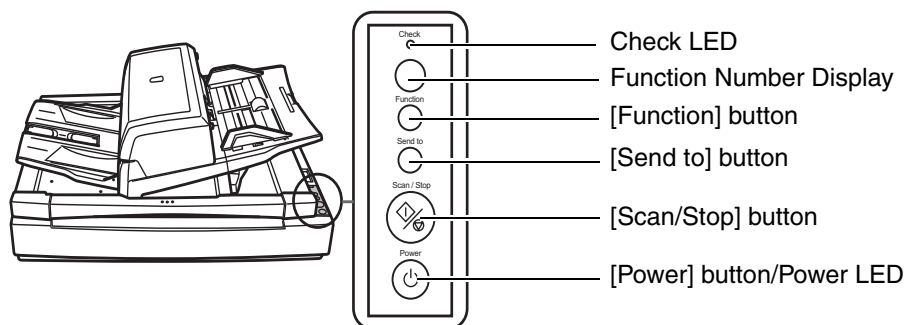

Name	Description
Check LED	Lights (in orange) when an error occurs.
Function Number Display	Indicates the scanner status.
[Function] button	Switches the function activated by the [Send to] button.
[Send to] button	Launches linked application software for scanning. Resets an error indication.
[Scan/Stop] button	Launches linked application software for scanning. Resets an error indication. Cancels ongoing scanning.
[Power] button/Power LED	Turns the scanner ON and OFF. Lights (in green) when the scanner is turned ON.

■ Indications on the Function Number Display

Indication	Function
8	Blinks only one time upon turning on the scanner.
P	Indicates that the scanner has been turned ON and is being initialized.
1	Indicates that the scanner is ready for scanning. This means initialization has ended successfully after power-on. This status is called "Ready Status."
J U	Indicates that a recoverable error occurred during scanning with the scanner. "J" or "U" and an "error number" are displayed alternately. For details of the errors, refer to "Temporary Errors" in the Operator's Guide. After the error has been resolved, you can return to the Ready Status (see "1" above) by pressing the [Scan/Stop] or [Send to] button.
E F C H A L	Indicates that an abnormality (device error) occurred in the scanner during its initialization or during scanning documents. "E", "F", "C", "H", "A", or "L" and an "error number" are displayed alternately. When the error number is displayed, turn the Main Power Switch OFF and then ON again. If the error persists after this, contact the dealer where you purchased the scanner or an authorized FUJITSU scanner service provider.

2

Installing the Scanner

The following describes how to install the scanner.

1 Place the scanner at its installation site.

The outer dimensions and the spaces required for installing the respective scanner types are as follows:

ADF type

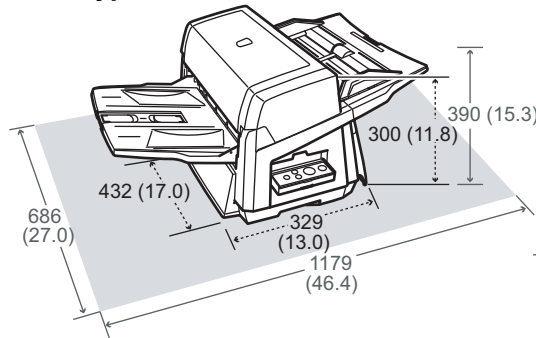

Flatbed type

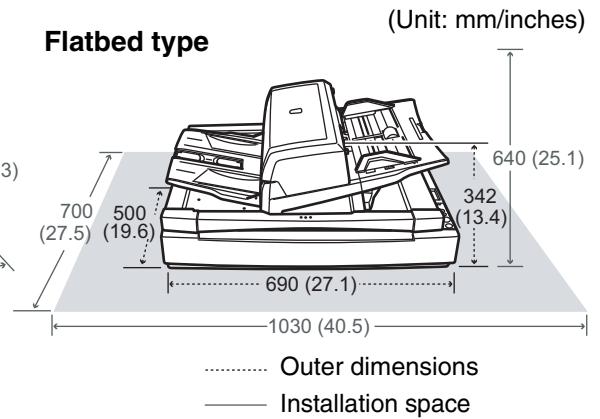

2 Unlock the Transport Lock (Flatbed type only).

Using a coin or similar, rotate the Transport Lock counterclockwise by 90 degree to unlock it.

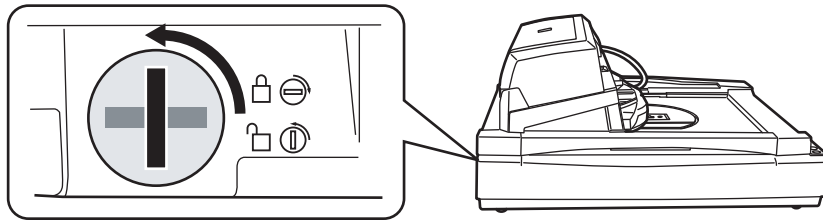

3 Adjust the position of the ADF (Flatbed type only).

1) Holding the handle, lift open the Document Cover.

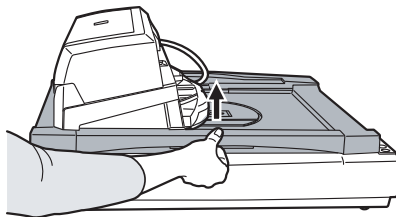

2) Remove the ADF Lock Screws, and then set them to the Lock Screw Storage Holes.

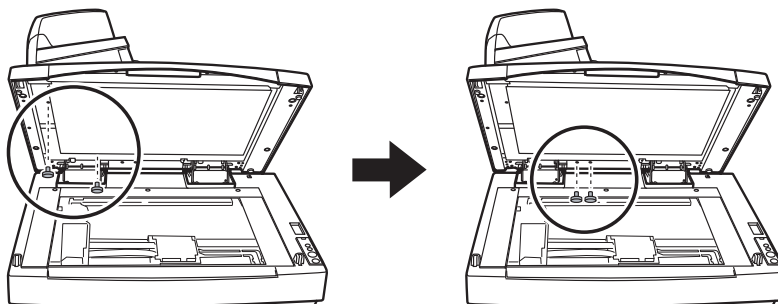

3) Gently close the Document Cover.

4) Change the position of the ADF.



- Be careful not to pinch your fingers when moving the ADF.
- Never rotate the ADF by more than 180 degree. Doing so may damage the ADF.

The ADF can be set to any of the following three positions:

After repositioning the ADF, be sure that the ADF is firmly locked to the new position.

■ Traditional (Factory default)

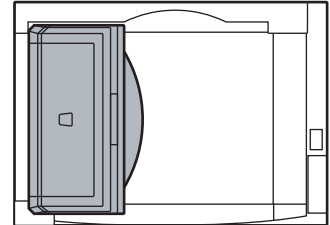

■ Standard (Space-saving type and for right-handed operators)

Slide the ADF toward the center of the scanner.

Note the following explanation in this manual is based upon this standard type of the scanner.

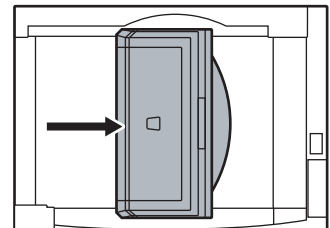

■ Reversed (Space-saving type and for left-handed operators)

Slide the ADF toward the center of the scanner, and then rotate it counterclockwise by 180 degree.

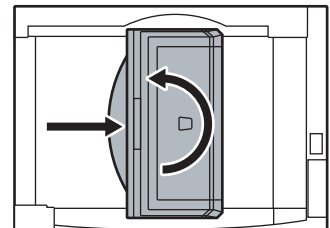

4 Attach the Stacker and the ADF Paper Chute to the scanner.

1) Insert the hooks of the ADF Paper Chute into their corresponding holes on the scanner.

2) Fit the protruding sections of the Stacker into their corresponding slots on the scanner.

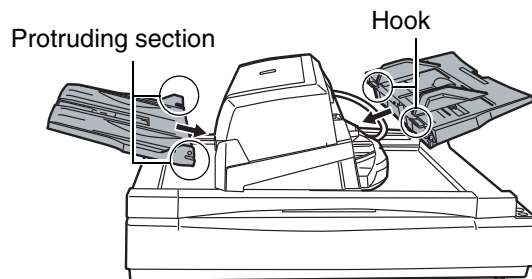

3

Connecting the Cables

The following describes how to connect the cables between the scanner and your computer.



The type of the connector for the cable depends on the scanner model you use. Confirm the scanner model and use the correct cable.

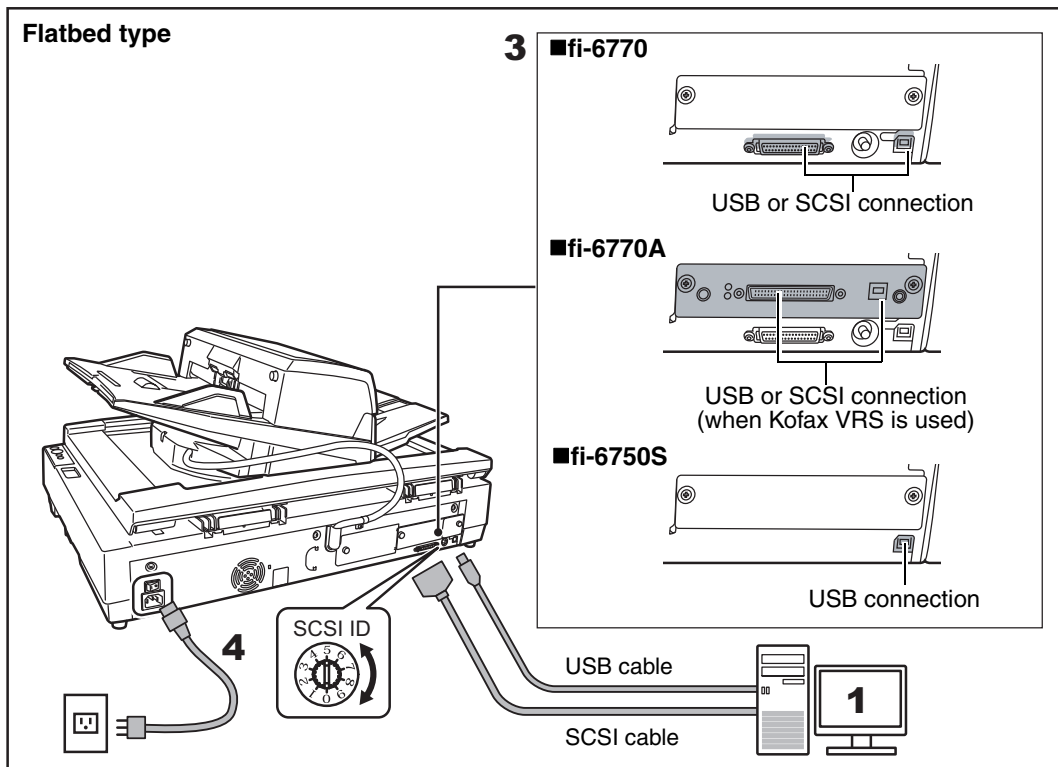
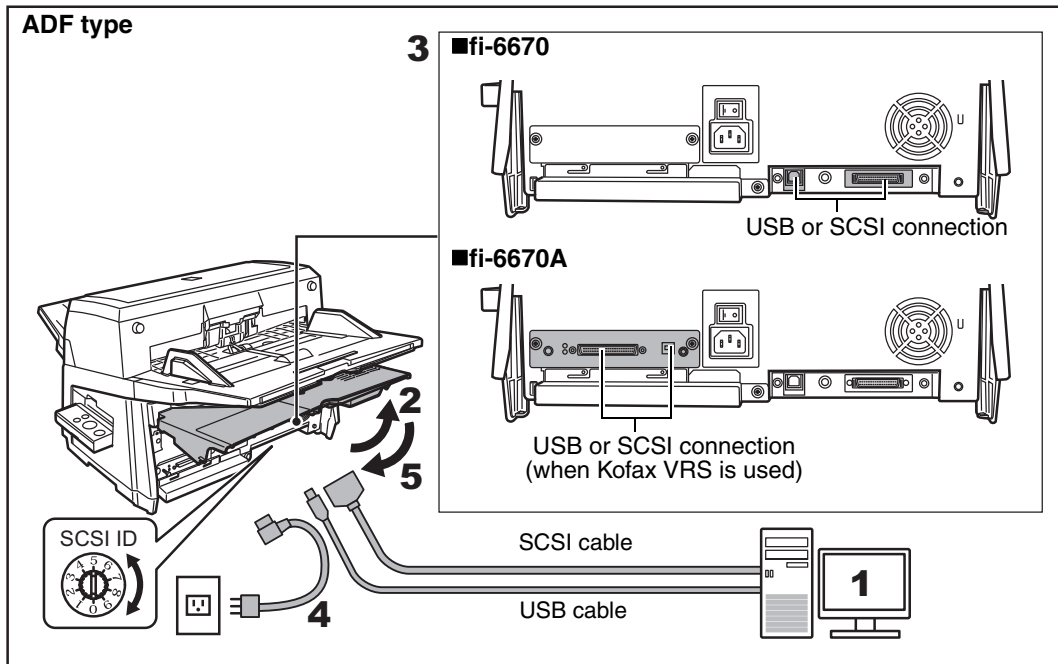

- 1 Make sure that the computer is turned OFF.**
- 2 Open the Cable Cover (ADF type only).**
- 3 Connect the scanner to your computer either with a USB or SCSI cable.**



- You cannot make both USB and SCSI cable connections at the same time.
- You cannot connect multiple computers to the scanner at the same time.
- If Kofax VRS is not used on the fi-6670A or fi-6770A, connect the cable to USB Connector 1 or SCSI Connector 1 on the scanner.
- Turn off the scanner and your computer first when you switch the interface cable.

The following describes the requirements for connecting with the respective cables.

■ USB cable

- Be sure to use the USB cable which comes as an accessory with this scanner.
- When connecting to an USB hub, use the first stage USB hub that is closest to the computer. If you use the second or later hub stages, the scanner may not operate correctly.
- If you connect the scanner with USB 2.0, it is required that the USB port and the Hub be compliant with USB 2.0. The scanning speed slows down when you connect the scanner with USB 1.1.

■ SCSI cable



Be careful not to damage any pins of the SCSI connector when connecting the scanner to your computer.

- When using the scanner with a SCSI interface, the following types of SCSI cable and SCSI card must be purchased.
- SCSI cable:
Use a SCSI cable whose connector on the computer side mates to the connector on the SCSI card installed on your computer.
On the scanner side, use either of the following SCSI cable types depending on the connector (1 or 2) used:
SCSI Connector 1: 50-pin high-density type
SCSI Connector 2: 68-pin high-density type
- SCSI card:
Find the recommended SCSI card information on the Fujitsu website (FAQ):
<http://www.fujitsu.com/global/support/computing/peripheral/scanners/scsi/>
- In a SCSI daisy chain formation, connect the scanner so that it is the terminated device.
- The SCSI ID initially set at the factory is [5]. If the SCSI ID of another SCSI device is set to the same ID, change the scanner's SCSI ID to [0] through [7].

4 Connect the Power cable to the Power Connector of your scanner and to the power outlet.



Be sure to use the supplied power cable. Use of other power cables may cause electrical shock or malfunction.
Do not use the supplied power cable for other products. Doing so may cause electrical shock or malfunction.

5 Close the Cable Cover (ADF type only).

Let the cables out from the side slots of the scanner.

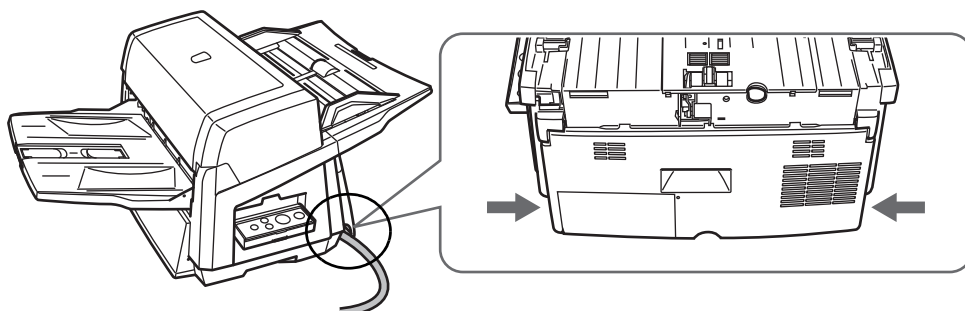

4

Installing the Scanner Software

Brief Information on the Bundled Software

To scan documents with this scanner, you must install a scanner driver for operating the scanner as well as scanning software (hereinafter called the "application") for launching the driver and performing a scan.

The scanner drivers and applications provided with the scanner are as follows:

■ TWAIN Driver

Conforms to the TWAIN standard. Used when you operate the scanner using TWAIN-compliant applications.

■ ISIS Driver

Conforms to the ISIS standard. Used when you operate the scanner using ISIS-compliant applications.

■ Software Operation Panel

Configures settings for scanning behavior and consumable management. Installed together with the scanner drivers (TWAIN/ISIS).

■ Error Recovery Guide

Shows the error status and the action to take when an error occurs. Can be installed together with the scanner drivers (TWAIN/ISIS). Note this manual will not work if you use Kofax VRS on the fi-6670A or fi-6770A.

■ Image Processing Software Option

A software option featuring advanced binarization of scanned images. Can be installed together with the scanner drivers (TWAIN/ISIS). Note this manual does not appear when Kofax VRS is used on the fi-6670A or fi-6770A.

■ Kofax VRS [VRS(scanner model names)] (*1)

A software program that allows you to generate high-quality images with a simple operation. Senses for any documents skewed during scanning, checks for any characters blurred during coloring or shading, and then corrects them automatically. Not available with the fi-6750S.

■ ScandAll PRO

ScandAll PRO is a software application for scanning images, which is in compliance with both TWAIN/ISIS standards. By assigning scan settings into batch profiles, it enables one-touch operations to perform scanning in ways that best suit your needs.

■ ScandAll PRO ScanSnap mode Add-in (hereinafter referred to as "ScanSnap mode")

An add-in application which provides a different set of driver settings as an alternative to using ScandAll PRO. TWAIN driver is required to use this application. Enables easy scanning with a single button. ScandAll PRO must be installed in order to install this software.

■ Scan to Microsoft SharePoint

Scan to Microsoft SharePoint is a software application for uploading files onto the SharePoint site via ScandAll PRO or ScandAll PRO ScanSnap mode Add-in. It can be installed together with ScandAll PRO.

■ ABBYY FineReader for ScanSnap™

Bundled for use with ScanSnap mode, this application converts scanned images into Microsoft® Office (Word/Excel®/PowerPoint®) files. Can be installed together with ScanSnap mode.

■ QuickScan Pro™ (trial) [QuickScan Pro (Trial)] (*1)

Conforms to the ISIS standard. By using the ISIS scanner driver together with QuickScan Pro™, you can read scanned documents and create their images. This bundled QuickScan Pro™ is a trial version, and can be executed 30 times before it is disabled. You will need to purchase the full product version if you wish to continue using it.

■ Manuals

Includes Getting Started, Operator's Guide, and "Read Before Using VRS".

■ Scanner Central Admin Agent

Used to centralize the management of multiple scanners, by allowing you to apply firmware updates simultaneously, monitor the operating status, and check the scanner information.

Note that required applications will differ depending on the form of operation.

For details, refer to the Scanner Central Admin 4.0 User's Guide.

■ Adobe Acrobat Standard

A de-facto standard application used for creating, editing, managing, and making use of digitalized documents in PDF format.

*1: The product ID used for its installation differs from the official product name. It is shown in [].

The software programs and their supported OSs are as follows:

	Windows 2000 Professional	Windows XP Home Edition (32-bit)	Windows XP Professional (32/64-bit)	Windows Server 2003 (32/64-bit)	Windows Vista (32/64-bit)	Windows Server 2008 (32/64-bit)	Windows 7 (32/64bit)
TWAIN	Yes	Yes	Yes	Yes	Yes	Yes	Yes
ISIS	Yes	Yes	Yes	Yes	Yes	Yes	Yes
Software Operation Panel	Yes	Yes	Yes	Yes	Yes	Yes	Yes
Error Recovery Guide	Yes	Yes	Yes	Yes	Yes	Yes	Yes
Image Processing Software Option	Yes	Yes	Yes	Yes	Yes	Yes	Yes
Kofax VRS	No	No	Yes (*2)	No	Yes (*1)	No	Yes (*1)
ScandAll PRO	No	Yes	Yes	Yes (*3)	Yes	Yes	Yes
ScandAll PRO ScanSnap mode Add-in	No	Yes	Yes	Yes (*3)	Yes	Yes	Yes
Scan to Microsoft Share-Point	No	Yes	Yes	Yes (*3)	Yes	Yes	Yes
ABBYY FineReader for ScanSnap™	No	Yes	Yes	Yes (*3)	Yes	Yes	Yes
QuickScan Pro™ (trial)	Yes	Yes	Yes (*2)	Yes (*2)	Yes (*2)	Yes (*2)	Yes (*2)
Manual	Yes	Yes	Yes	Yes	Yes	Yes	Yes
Scanner Central Admin Agent	No	Yes	Yes	Yes (*4)	Yes	Yes	Yes
Adobe Acrobat Standard	No	Yes	Yes	Yes	Yes	No	Yes

Yes: Supported No: Out of guarantee or not supported

*1: Kofax VRS supports the following Windows Vista versions:

- Windows Vista Business
- Windows Vista Enterprise
- Windows Vista Ultimate

Kofax VRS supports the following versions of Windows 7:

- Windows 7 Professional
- Windows 7 Enterprise

*2: Does not support the Windows 64-bit versions.

*3: ScandAll PRO, ScandAll PRO ScanSnap mode Add-in, Scan to Microsoft SharePoint, and ABBYY FineReader for ScanSnap™ support the following versions of Windows Server 2003:

- Windows Server 2003 R2, Standard Edition
- Windows Server 2003 R2, Standard x64 Edition

*4: Scanner Central Admin Agent supports the following versions of Windows Server 2003:

- Windows Server 2003 R2, Standard Edition
- Windows Server 2003 R2, Standard x64 Edition

Installing the Bundled Software

The following describes how to install the bundled software from the "Setup DVD-ROM" contained in the scanner package.

You can select either the [INSTALL (Recommended)] or [INSTALL (Custom)] menu when installing the Setup DVD-ROM.

The former installs all the software programs needed to operate the scanner; the latter installs the selected software programs one by one.

For how to install Adobe Acrobat, refer to "Installing Adobe Acrobat" (on page 23) in the next section. If the disk (called the Setup DVD-ROM) is loaded, the window appearing first will ask you to select the model you want to use. Select your scanner model, and then install the required software.

INSTALL (Recommended)

The software programs to be installed differ depending on the scanner model to use.

The scanner models and their installable software programs are as follows:

	fi-6670/fi-6670A/fi-6770/fi-6770A	fi-6750S
TWAIN	Yes	Yes
ISIS	Yes (*1)	No
Software Operation Panel	Yes	Yes
Error Recovery Guide	Yes	Yes
Image Processing Software Option	Yes	Yes
Kofax VRS	Yes	No
ScandAll PRO	Yes	Yes
ScandAll PRO ScanSnap mode Add-in	Yes	Yes
ABBYY FineReader for ScanSnap™	Yes	Yes
Manual	Yes	Yes
Scanner Central Admin Agent	Yes	Yes

Yes: Installed No: Not installed

*1: Not installed with fi-6670A/fi-6770A.



If an old version of the software is installed already, uninstall it first.
For how to uninstall each of the software, refer to "Appendix 5 Uninstalling the Software" in the Operator's Guide.

The following describes how to install the software.

1 Confirm that the scanner is not turned ON.

2 Turn on your computer and log onto Windows.



Be sure to log on as a user with "Administrator" privileges.

3 Insert the Setup DVD-ROM into your disk drive.

⇒ The [FUJITSU Image Scanner Setup] screen appears.



If this screen does not appear, find "AutoPlayer.exe" in the Setup DVD-ROM using "Windows Explorer" or "Computer" and execute it directly.

4 Click [fi-6670/fi-6670A fi-6750S fi-6770/fi-6770A] and click the [Next] button on the displayed screen.

5 Click the [INSTALL (Recommended)] button.

⇒ The list of scanners appears.

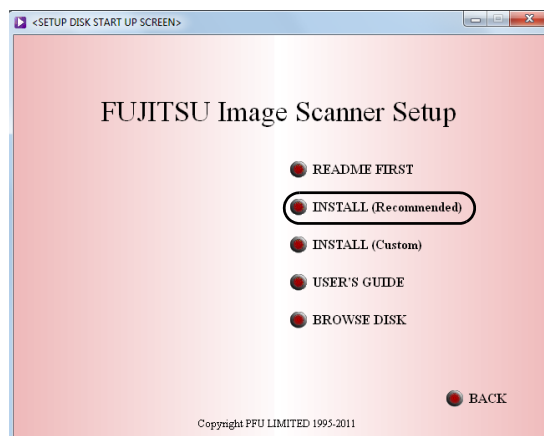

6 Select the scanner model name you will be using. Then, click the [Next] button.

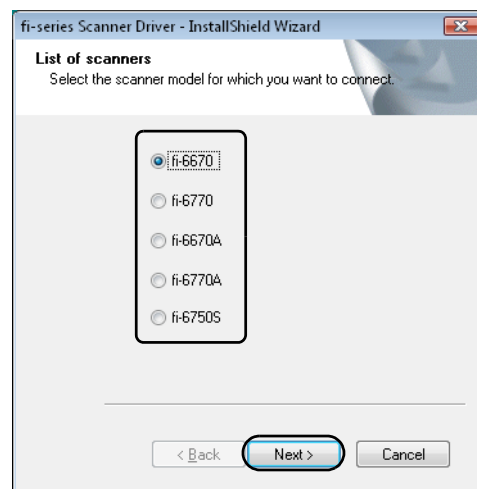

7 Install the software, following the on-screen instructions.

INSTALL (Custom)

This menu lets you select and install the required software programs one by one. The procedure for custom-installing the required software is as follows:



If an old version of the software is installed already, uninstall it first. For how to uninstall each of the software, refer to "Appendix 5 Uninstalling the Software" in the Operator's Guide.

1 Confirm that the scanner is not turned ON.

2 Turn on your computer and log onto Windows.



Be sure to log on as a user with "Administrator" privileges.

3 Insert the Setup DVD-ROM into your disk drive.

⇒ The [FUJITSU Image Scanner Setup] screen appears.



If this screen does not appear, find "AutoPlayer.exe" in the Setup DVD-ROM using "Windows Explorer" or "Computer" and execute it directly.

4 Click [fi-6670/fi-6670A fi-6750S fi-6770/fi-6770A] and click the [Next] button on the displayed screen.

5 Click the [INSTALL (Custom)] button.

⇒The [INSTALL PRODUCTS] screen appears.

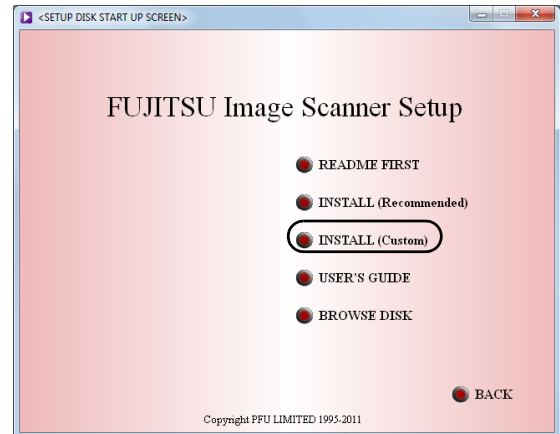

6 Click the button for the software to be installed.

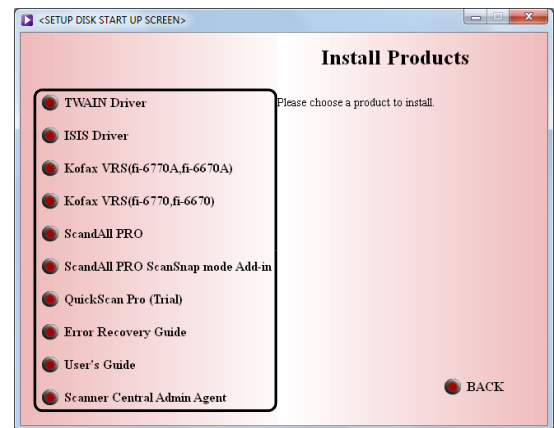

7 Install the software, following the on-screen instructions.

Repeat Steps 5 and 6 to install other software program(s) here.



For how to install Kofax VRS, refer to "VRS NOTE" included in the Setup DVD-ROM.

Installing Adobe Acrobat

Install Adobe Acrobat using the following procedure from the "Adobe Acrobat DVD-ROM" supplied with this product.

Prepare the Adobe Acrobat DVD-ROM.

1 Insert the supplied "Adobe Acrobat DVD-ROM" into the DVD drive.

The DVD-ROM is recognized automatically, and the following dialog box appears.

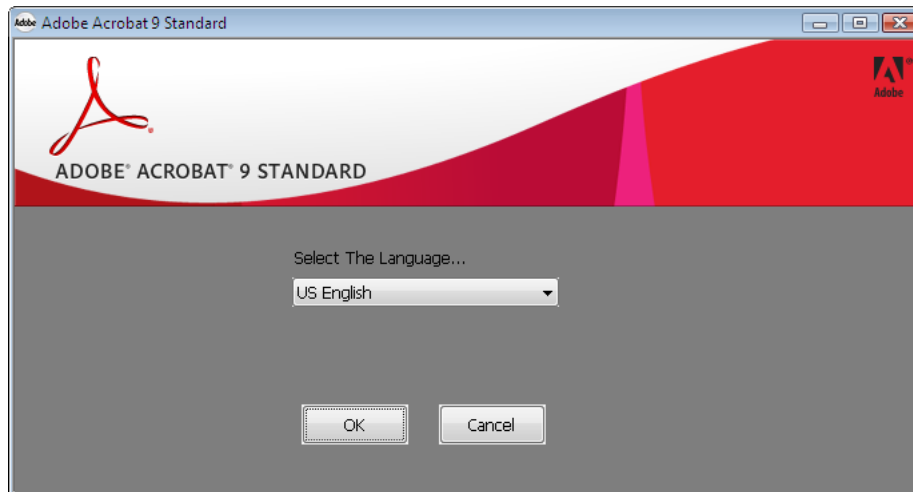

This window is not displayed automatically when the "Auto play" setting of your computer is deactivated. In this case, run "AutoPlay.exe" of this DVD-ROM directly using the "Explore" or "(My) Computer."

2 Select [US English] in "Select The Language...", and then click the [OK] button.

The following dialog box appears.

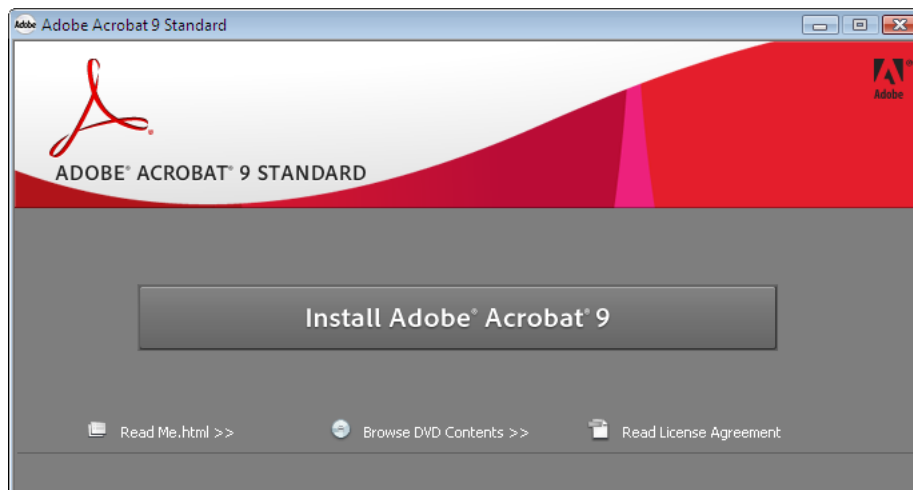

3 Follow the on-screen instructions to install the software.



Refer to "Adobe Acrobat Help" about how to use Adobe Acrobat.

This Acrobat version does not support Windows 2000 and Windows Server 2008.

5

Test-Scanning Documents

Using ScandAll PRO, you can test-scan documents to check if they are scanned with the ADF correctly. For how to scan documents with the flatbed, refer to “Chapter 5 Various Documents” in the Operator’s Guide.

The following describes how to test-scan a document:

1 Turn on the scanner.

1) Press the “I” side of the main power switch of the scanner.

2) Press the [Power] button on the Operator Panel.

The scanner is turned ON, and the Power LED on the Operator Panel lights in green.

Note that while the scanner is being initialized, the indication of the Function Number Display changes as; “8” ⇨ “P” ⇨ “1”, where “1” means that the Operator Panel is in the Ready Status.



If you see an error indication other than the above on the Function Number Display, refer to “Chapter 8 Troubleshooting” in the Operator’s Guide.

Ex. :If “U” is displayed on the Function Number Display, it means that the Transport Lock remains locked. In such case, you need to unlock the Transport Lock.

For how to unlock the Transport Lock, refer to “Section 2 Installing the Scanner” (on page 12).

ADF type

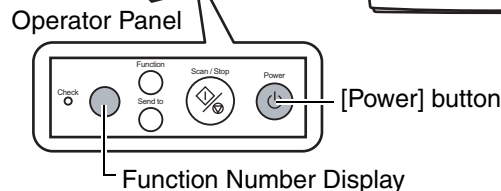
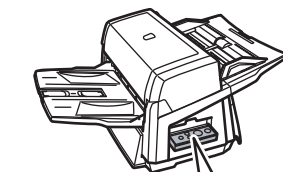

Flatbed type

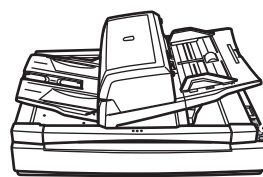

Operator Panel

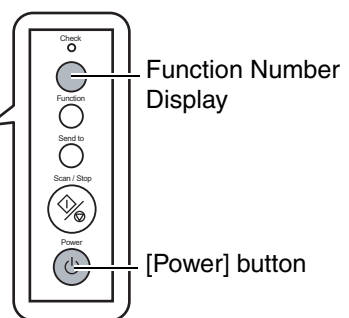

2 Turn on your computer.



For a SCSI connection, turn on the scanner and confirm that the Function Number Display shows “1.” Then, turn on your computer.

3 The scanner is automatically detected, and the [Found New Hardware] dialog box appears.

Select [Locate and install driver software (recommended)] to install the driver, following the on-screen instructions.

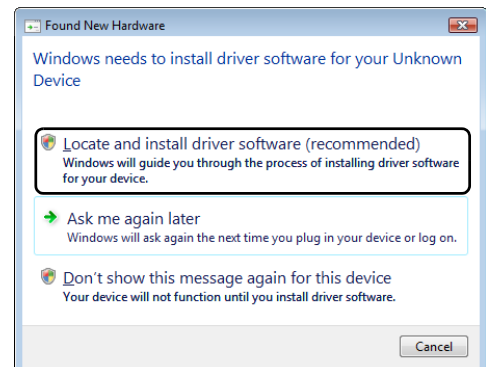

If the connection is made via SCSI Connector 2, there is no need to install the driver here. Just select [Don't show this message again for this device].

4 Load a sheet into the scanner.

- 1) Load the document on the ADF Paper Chute face down.
- 2) Align the side guides to the width of the document.
- 3) Pull out the Stacker to the length of the document, and then raise the Stopper.

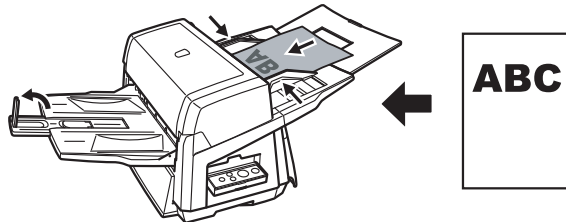

5 Launch ScandAll PRO.

Select the [start] menu ⇒ [All Programs] ⇒ [Fujitsu ScandAll PRO] ⇒ [ScandAll PRO].

6 Select the [Tool] menu ⇒ [Preferences].

⇒ The [Setup] dialog box appears.

7 On the [Scan] tab, select a driver to use, and then click the [OK] button.

When the connection is made via SCSI/USB Connector 2, select [ISIS/VRS].

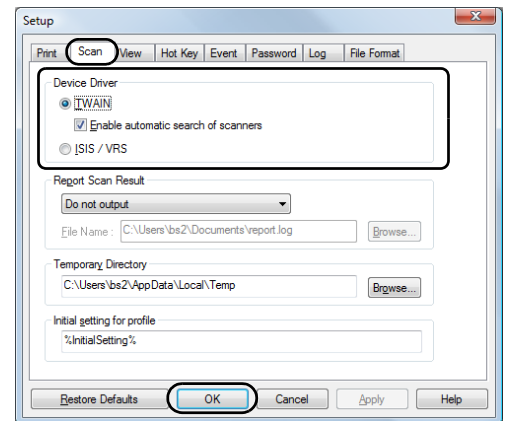

8 Select the [Scan] menu ⇒ [Select Scanner].

⇒ The [Select Scanner] dialog box appears.

9 Select the scanner you want to use, and then click the [Select] button.

Select the scanner model which is connected to your computer. The list of scanner models varies depending on the scanner driver installed.

If the connection is via SCSI/USB Connector 2, select "Kofax VRS Scanner."

Model	TWAIN	ISIS/VRS	
	TWAIN	ISIS	Kofax VRS
fi-6670	FUJITSU fi-6670dj	Fujitsu fi-6670	Kofax VRS Scanner
fi-6670A			
fi-6770	FUJITSU fi-6770dj	Fujitsu fi-6770	
fi-6770A			
fi-6750S	FUJITSU fi-6750Sj	Fujitsu fi-6750S	--



If “Kofax VRS Scanner“ does not appear in the list, check if the interface cable is properly connected to SCSI/USB Connector 2.
 If “Kofax VRS Scanner“ does not appear even after you have connected the cable properly, then refer to “Chapter 8 Troubleshooting“ in the Operator’s Guide.



When using Kofax VRS for the first time, the [Register Kofax VRS] screen appears. User registration is required to obtain support information from Kofax as well as to upgrade the software, though Kofax VRS can still be used without user registration.
 To register later, select [Start] menu - [All Programs] - [Kofax VRS] - [Kofax VRS Administration Console], and follow the on-screen instructions.
 For details, refer to the Kofax VRS Installation Guide (PDF) which is included in the Setup DVD-ROM (\VRS\SVRS\SVRS\Documentation).

10 Select the [Scan] menu ⇒ [Scan Settings].

⇒ The [Scan Settings] dialog box appears.

11 Clear the [Save to file] checkbox.



You only check the operation now, so you do not have to save to file.

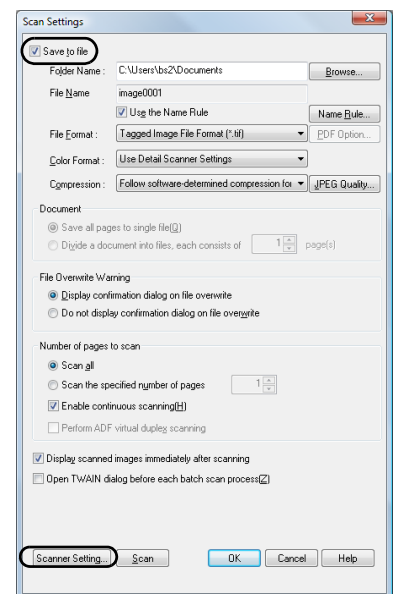

12 Click the [Scanner Setting] button.

⇒ The scanner driver’s setting dialog box appears.

13 Configure scanner settings such as the resolution and paper size.

■ TWAIN scanner driver

Configure scan settings, and then click the [OK] button.



The setting dialog box of the scanner driver may be displayed again after the [OK] button is clicked. In such case, click the [Scan] button in the dialog box.

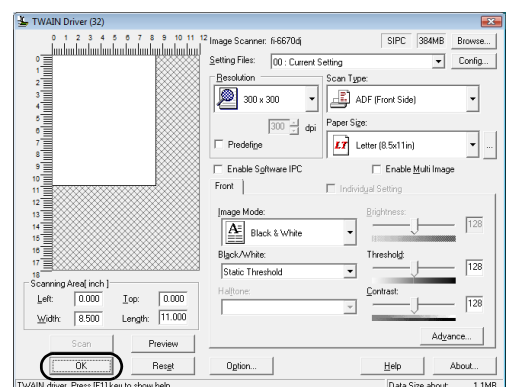

■ **ISIS scanner driver**

Configure scan settings, and then click the [OK] button.

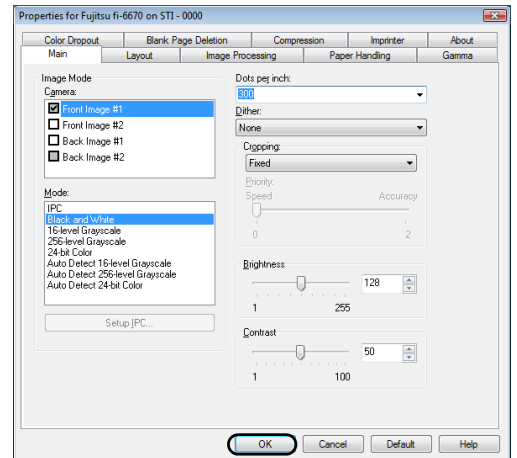

■ **Kofax VRS**

Configure scan settings, and then click the [OK] button.

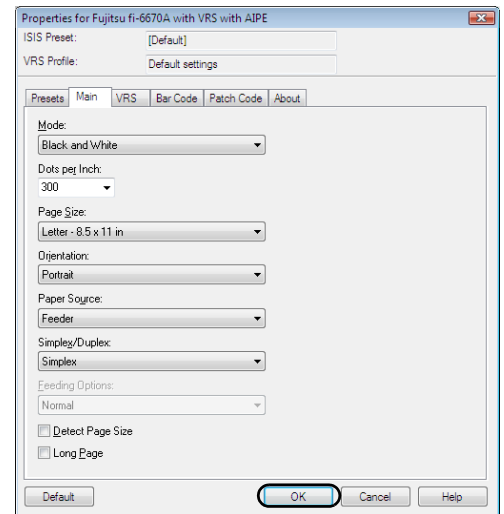

14 In the [Scan Settings] dialog box, click the [Scan] button.

⇒ The scanned document images are displayed in the ScandAll PRO window.

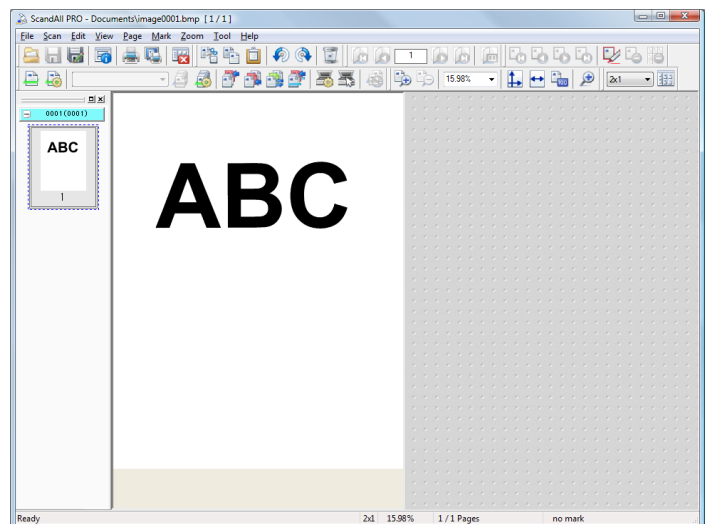

Refer to “Chapter 8 Troubleshooting” in the Operator’s Guide, in case you see a number and an alphabet displayed on the Function Number Display.

For information about other scanning features, refer to “Chapter 5 Various Documents” in the Operator’s Guide contained in the Setup DVD-ROM.

For the fi-6670A or fi-6770A, it is recommended that you perform a scan using Kofax VRS. For details about Kofax VRS, refer to the Kofax VRS Help.

fi-6670(A)/fi-6770(A)/fi-6750S Image Scanner Getting Started

P3PC-2242-03EN

Issue Date: October 2011

Issued by: PFU LIMITED

-
- Copying of the contents of this manual in whole or in part and copying of the scanner application is prohibited under the copyright
 - The contents of this manual are subject to change without notice.
 - PFU LIMITED is not liable whatsoever for any damages resulting from use of this scanner and procedures described in this manual, profit due to defects, and any claims by a third party.